

Z SERIES AGRICULTURAL DRONE SYSTEM

(Model: Z30/Z50)

Assembly Instruction Manual

Version 1.0 EN2023



Contents

Safety Guidelines	1
In The Box	2
Preparations	3
Installation Steps	4
Parts Introduction	4
Flow Chart	4
Steps	5
Step 1: Install landing gear	5
Step 2: Install motor set and drone arms	6
Step 3: Connect Cables	8
Step 4: Install The Centrifugal Nozzles	10
Step 5: Install Camera	10
Ending :	11
Switch Spreading Tank	11
Specifications	12

Safety Guidelines

1. Please carefully check the goods according to the product list before assembly, complete the installation according to tutorial video or this manual.
2. Make sure that you have well known the each part of this product before assembling this product. Do not assemble it violently. If you have any questions when assembling this product, please contact EFT or the authorized agency.
3. Not being a toy, plus for certain safety risks, the product is not suitable for those who are under 18 years old, or those who have no or limited capacity for civil conduct, or those with mobility impairments, or those restricted by existing laws, regulations and policies. Please keep the product out of reach of children and be particularly cautious while there are children present.
4. Before installing this product, please make sure that you have fully understood the features and functions of the Z series products, have professional installation and debugging techniques, and strictly follow this manual to install the various parts of the drone. Incorrect assembly may cause personal injury or the device is not running properly.
5. During assembly, please check each component carefully to see that it is properly connected and all in the correct position.
6. During the installation, please operate carefully to avoid damage and loss caused by improper operation.
7. When installing the water pipe, do not bend it much to avoid creases and affect the spraying effect.
8. For replacement parts, please purchase original repair parts. The components from other sources may cause failure and users shall take the risk.
9. Unauthorized disassembly, modification, installation or use of this product for purposes other than the original design is prohibited, otherwise the warranty will be invalidated.
10. Be sure to connect and insert the battery and turn on the power after completing all the installation and wiring.
11. Please complete all assembly and no-load flight test, spraying inspection, and then carry out field operations.
12. Before test, please confirm whether the remote control can be connected normally and whether the battery power is sufficient. During testing, make sure the drone is in an open area to avoid hitting obstacles or people.

Warning

Improper assembly will affect product performance, please ensure that you have professional installation and debugging techniques, and strictly follow with this manual. We do not accept any return or exchange due to subjective factors, such as subjectively determined that it is not easy to use, don't know how to use, and the performance does not meet the expected, which are non-product quality problems. All damages and risks from personal reasons during assembly and operation shall be borne by the users, we do not assume any related liability.

In The Box

When unpacking, please check that all items in this checklist are included according to the package you purchased. If there is something missing, please contact our after-sales customer service team in time.

Product Form: CKD

Number of packages: 2

Packaging Materials: Carton + protective foam

The packaging reference is as follows:



Box 1: ①drone body ②landing gear ③ motor set ④paddle ⑤paddle clip ⑥fittings



Box 2: ①Tanks and Sprinklers ② Remoto control ③Centrifugal nozzles

Three solutions are optional, as follows:

Item	Basic set	Advanced set	Standard set
Drone frame	√	√	√
Motor set*4	√	√	√
Impeller pump*2	√	√	√
Flowmeter	√	√	√
Liquid level gauge	√	√	√
Centrifugal nozzle*2	√	√	√
Switchboard	√	√	√
Piping fittings	√	√	√
Flight control	√	√	√
Receiver	√	√	√
Camera	√	√	√
Remote control	√	√	√
RTK	X	X	√
Rear radar	X	√	√
Front radar	X	√	√
Altitude Radar	X	√	√

* Warm tips:

Due to long distance international shipments, the product protruding parts may be cracked by pressure, vibration and violent transportation, especially at the interface of the flowmeter, which may cause water leakage. We strongly recommend that you carefully check each part for deformation, cracks or other damage after receiving the goods. If there is any problem, please contact us and apply for replacement.

Preparations











Required tools

1. Screwdriver Set: For tightening and loosening screws.
2. Extended screwdriver (M4, M5 models): For tightening and loosening screws.
3. Screw glue (provided): For locking screws, bolts and nuts.
4. Grease (provided): For sealling the plug.
5. Scissors/utility knife: For cutting wires, tape, etc.
6. Level: Used to level the motor set.
7. Hexagonal socket 6mm: For tightening and loosening the hexagonal stud at the locking buckle of the arms.
8. Ordinary safety gloves.

Inspection

- Check the model, specification, the number of boxes, accessories, and the compatibility of each parts according to the list of items. If there are something wrong or missing, please take photos as evidence.
- Check whether the components are in good condition, whether the tripod is deformed, whether the internal flight control is loose, whether the plug connector is skewed or falling off, whether there is any crack at the flow meter connector, etc. If there are any of the above situations, please contact customer service as soon as possible.

Mounting fittings

Item	Spec.	Qty	Application
	Tee Fixing	4	landing gear bar
	Sticker	4	Arm locking handle and Motor base
	Grease	1	The plug of the signal cable
	Screw fastening glue	1	Arm mounting
	Camera bracket	1	Camera installation
	M4*35 Cylindrical screw+M4 nut	1	
	M3*8 Cylindrical screw	2	Locking handle installation
	$\Phi 8*23$ Long pin*4	4	
	$\phi 8*17$ Short pin	4	
	M4*75+6 Hex stud	4	
	M4*12 Cylindrical screw	4	Arm installation
	Gasket	8	
	M6*12 Locking screw	4	
	$\phi 8*M6*78$ Locking nut	4	Landing gear fixtures
	M4*10 Cylindrical screw	12	
	M4*20 Cylindrical screw	16	
	M4*30 Cylindrical screw	4	landing gear bar
	M3*16 Cylindrical screw	8	Nozzle installation

Installation Steps

Parts Introduction

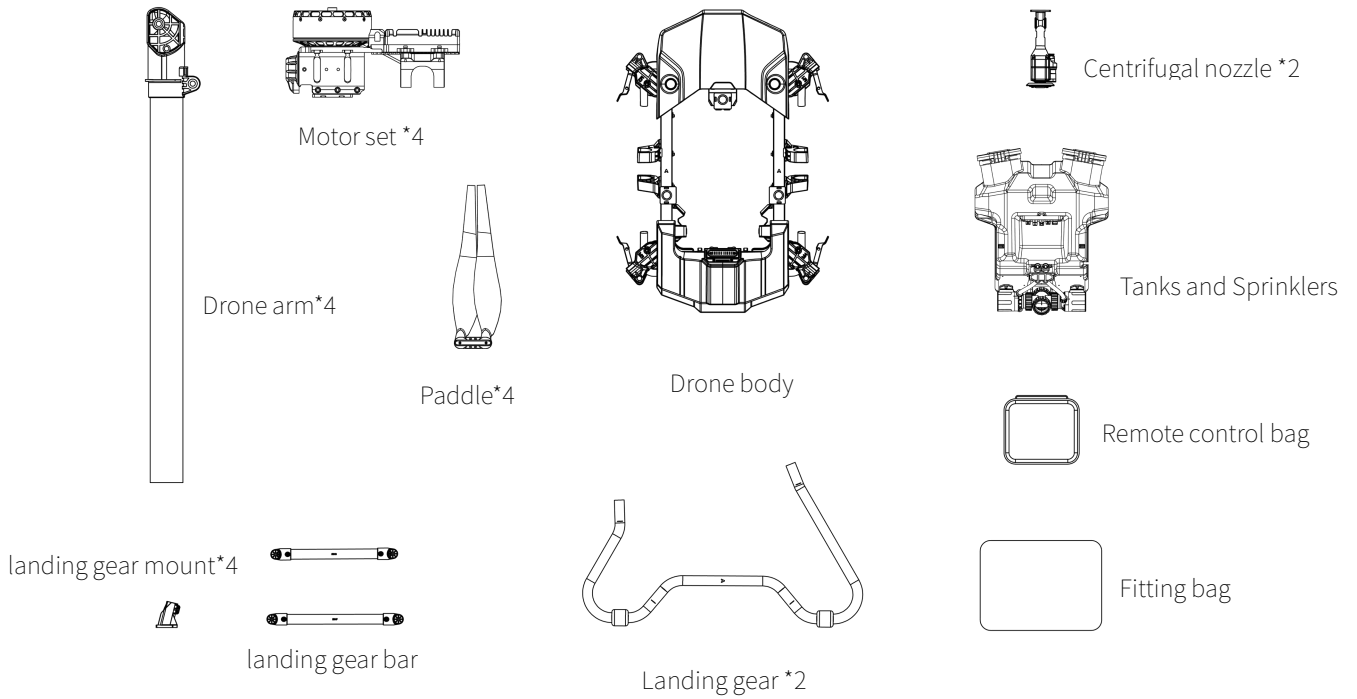

Flow Chart

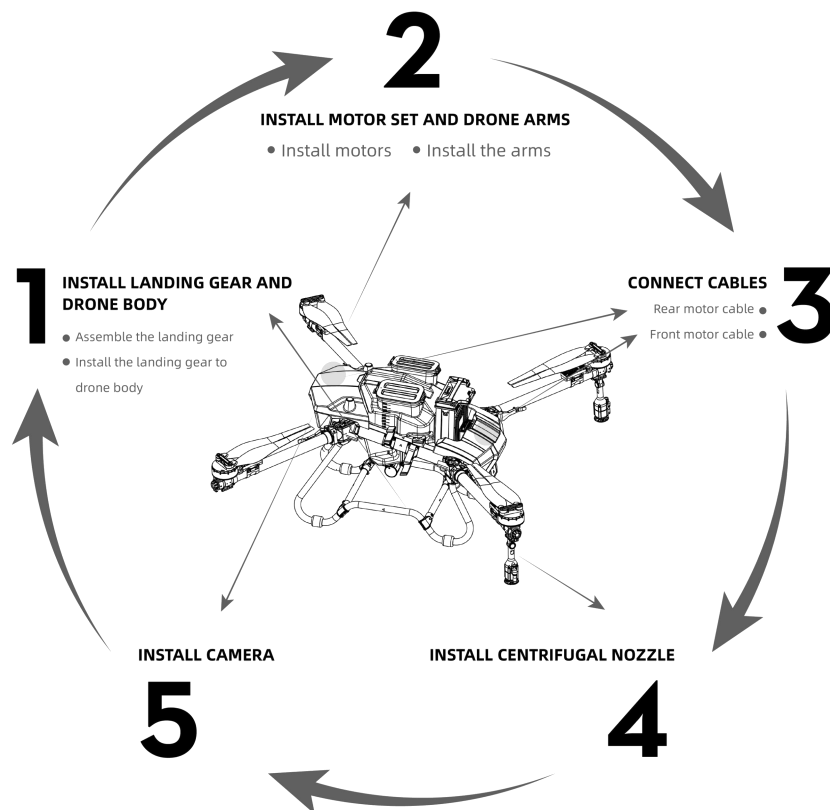

Steps

Step 1: Install landing gear

1. Open the package, take out the drone frames , the landing gear and crossbar components as well as the mountings and screws.



2. Remove the front and rear upper and lower covers to facilitate the turn over the frame and subsequent assembly.



3. Insert the mounts into both ends of the bent legs.



4. Turn the frame over, then install the bent legs on the frame, note the arrow to head. Use M4*20 screws to fasten, and then use M4*12 screws to fix the mounting seat .Do not fasten to facilitate the frame leveling.

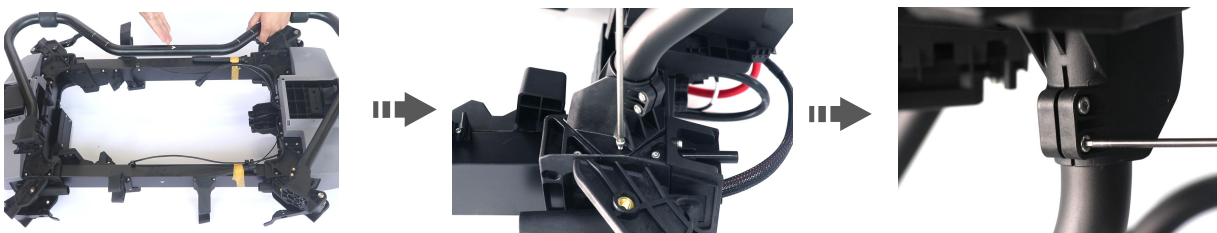

5. After installing the landing gear on both sides, install the four tee fixings according to the positioning marks on the bent legs, and pay attention to the interface horizontally inward.



6. Insert the front crossbar F (351mm) and the rear crossbar B (322mm) into the tee fittings, and fasten them with M4*30 half-thread screws.



7. Restore the receiver antenna, remove the tape, and fix the antenna with M4*10 cylindrical screws.



8. After the landing gear is installed, press the frame to level the drone, and then tighten the mounting seat of the landing gear.



Step 2: Install motor set and drone arms

Tips

*Pay attention to each arm label and motor code, clockwise from the head is M1-M4 in turn, install CCW at M1 and M3, and install CW at M2 and M4.

*The M1 and M2 arms with the motor cable, But the M3 and M4 arms will through the water pipe and the nozzle adapter cable first, and then threaded into the motor cables, and then lightly lock them to avoid falling off.

*It is recommended to install the propeller when test the aircraft. Note that the CCW and CW motor are respectively adapted to the corresponding paddles.

1. Take one of CW and one of CCW, and pass the nozzle adapter cable and water pipe through the motor head, and the other two motors no need.



2. Insert the 4 motor sets and cables into the carbon tube arm, and fix them with the screws on the motor base, do not tighten them for adjusting later.



3. Install the spacer on the arm head swivel position .



4. Remove the wire buckle and the cable-passing seal.



5. Put the arm with the nozzle adapter cable, the water pipe into the rear frame folder, and the arm without the water pipe into the front frame folder, then use the $\phi 8^*M6^*78$ lock nut to penetrate from the upper part. The lower M6*12 pair lock screws need to be glued (*the glue has been supplied as standard*) (*the cable faces forward and the water pipe faces backward*).

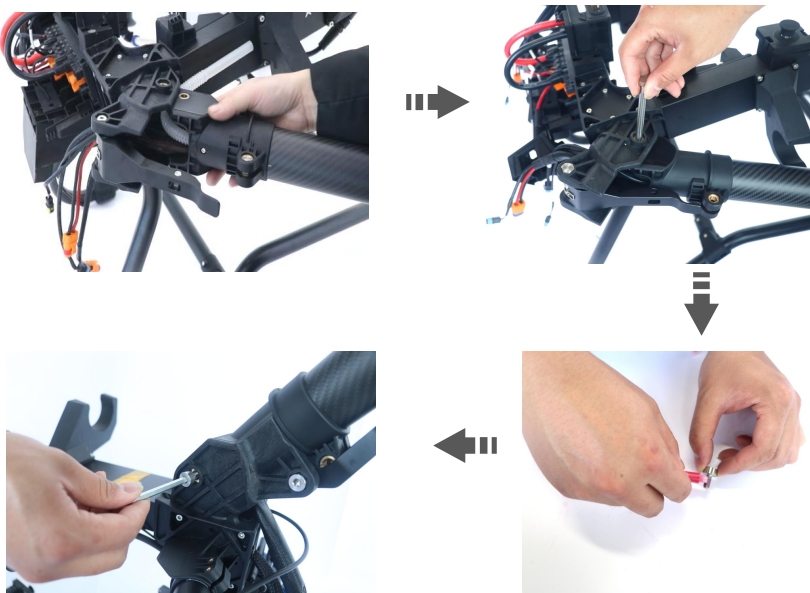

6. Install the locking buckle of the arm, insert the long pin into the hole of the arm holder, insert the short pin into the hole of the handle, and then insert the hexagonal stud into the long pin at the end of the arm.

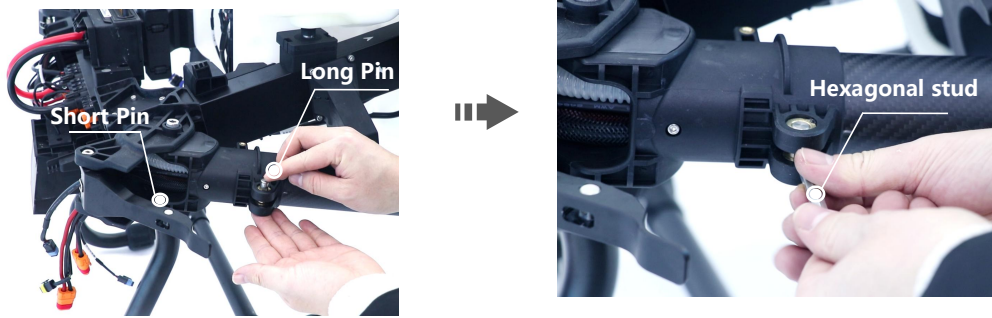

7. Adjust the arm handle to a suitable angle, use M4*12 screws to pass through the short pin of the handle, insert into the hexagonal stud and tighten.

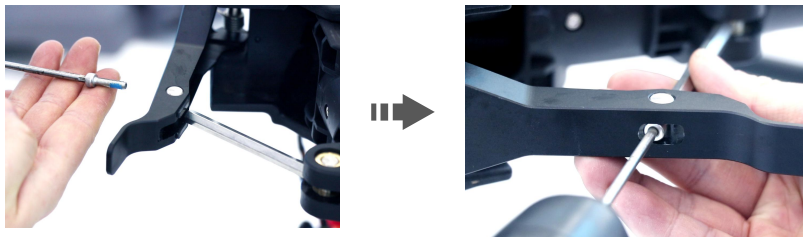

8. Affix 'Watch Your Fingers' on the buckle of the arm and 'Mind The Blade' on the motor fixing place.

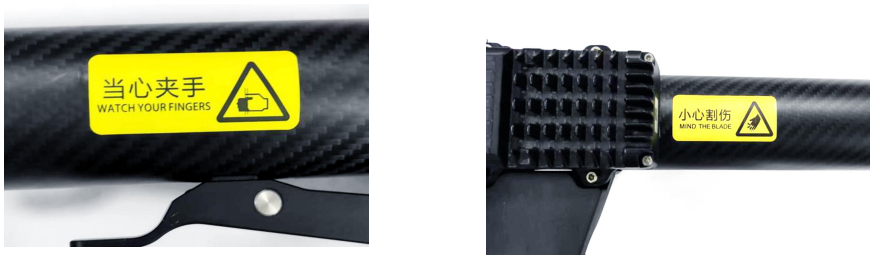

9. Follow the above steps to install the remaining arms and motors.



Step 3: Connect Cables

1. Pass each cable of the motors through the cable-passing seal, and then restore the seal.

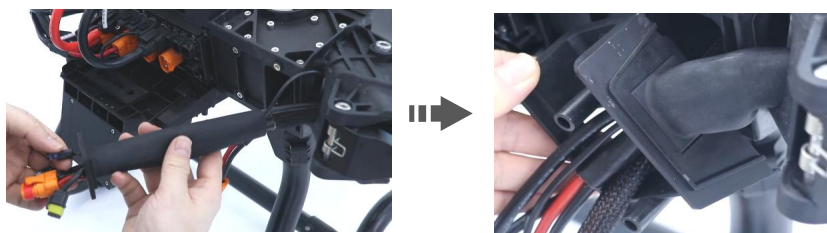

2. Assemble the wire buckle to the frame, adjust the length of the cables to facilitate the insertion.

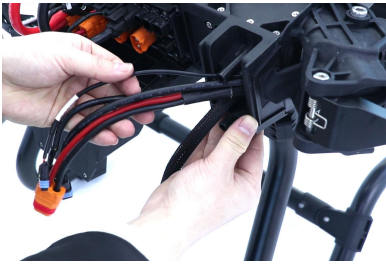

3. Please check the pins of each interface before wiring, and connect them correctly according to the label to avoid wrong insertion.

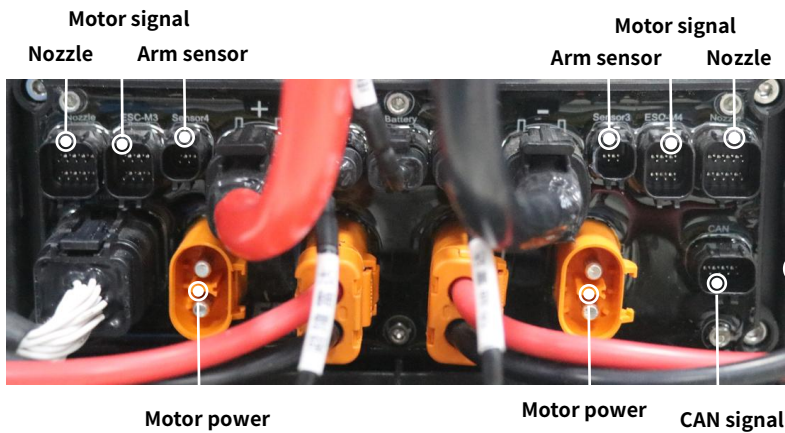

Rear Circuit Board

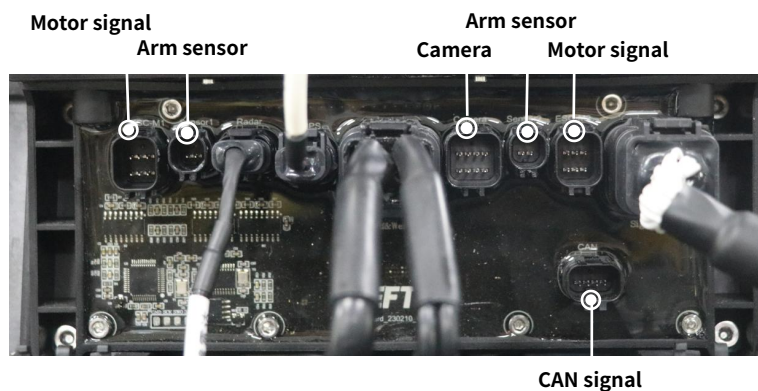

Front Circuit Board

4. Arrange the internal cables, make sure that the power transfer cable on the left of the front cover is connected with the motor cable on the right, and the power transfer cable on the right is connected with the left motor cable, and then plug the 4 power cables into the rear circuit board.

Note: *When installing the power cable, Up is the positive pole [red positive, black negative].

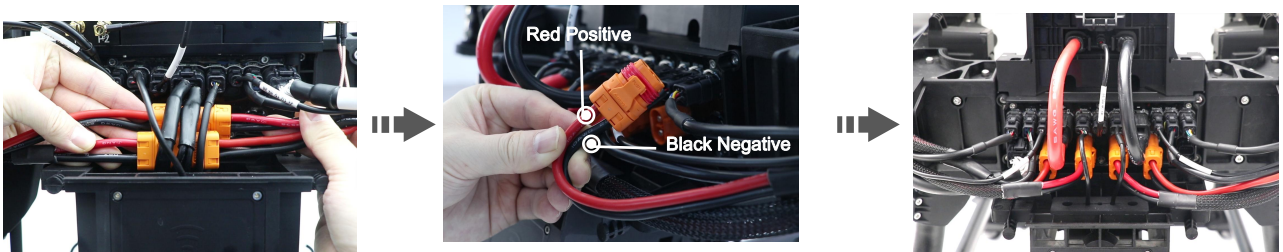

5. Apply grease to the sealing ring of the signal plug, and insert them into the corresponding positions according to the marks.

Note: Do not skew when plugging in. If it cannot be inserted, you need to check whether the internal pins are bent or wrong port.



Step 4: Install The Centrifugal Nozzles

1. Remove the power module of the centrifugal nozzle, insert the adapter cable into the inside of the bracket, and fasten it under the rear motor set with 4 M3*16 screws (the notch faces outward, which is convenient for water pipe installation).

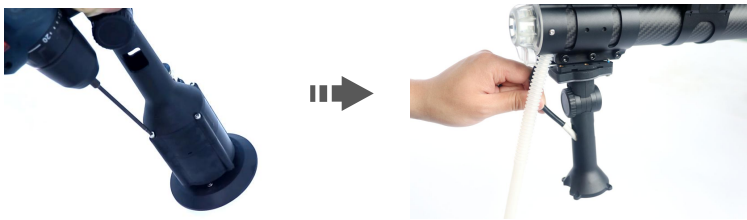

2. Insert the nozzle adapter cable into the motor terminal, then restore the nozzle.

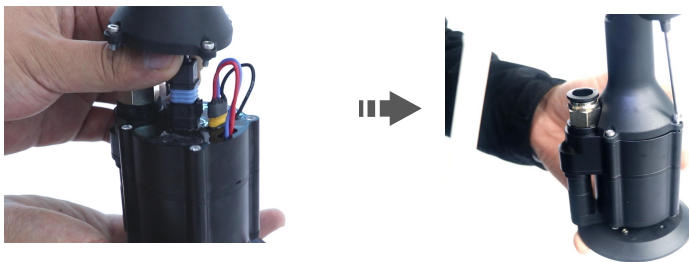

3. Finally insert the water pipe into the motor pneumatic connector.



Step 5: Install Camera

1. Use M3*8 screws to install the adapter on the camera, and use M4*35 half-thread screws and locknuts to install it on the front body.

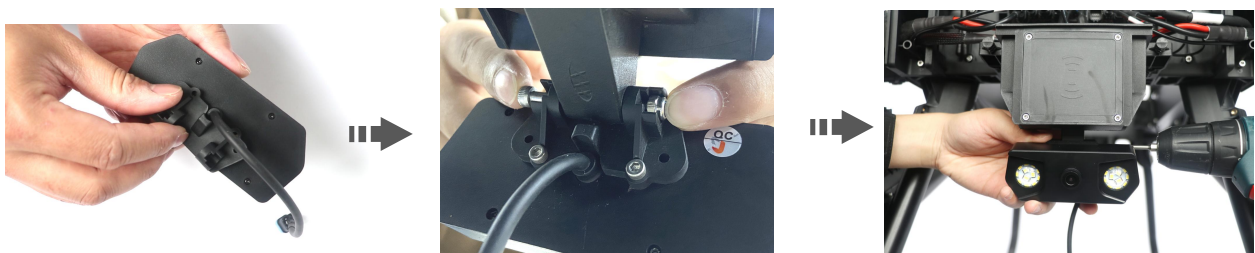

2. Pass the camera harness through the seal at the bottom and insert the plug into the front circuit board.



Ending:

1. After the above parts are installed, restore the front and rear drone upper and lower covers to their original positions.



2. Finally, use a level to adjust the motor, and then tighten the screws. It is recommended to install the propellers when outdoor test.



Switch Spreading Tank

1. To disassemble the sprinkler system, first disconnect the water pipes which connected to the water pump and the multi-function cable, then take out the spray tank.

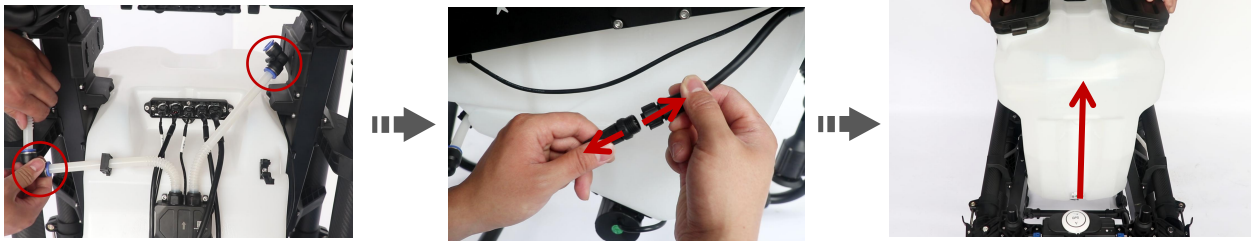

2. Put the spread tank with the spreader into the drone body and fix it, then connect the spreading cable with the multi-function adapter cable that fixed in drone body.



Tip: This manual is only for assembly guide. Please refer to *Z Series User Manual* for detailed operation. If you have any questions, please contact EFT or an officially authorized agent.

Specifications

Item	Parameter	Z30	Z50
Drone system	Unloaded Spraying drone weight (without batteries)	29.8kg	31.5kg
	Unloaded Spraying drone weight (with batteries)	40kg	45kg
	Unloaded Spreading drone weight (without battery)	30.5kg	32.5kg
	Unloaded Spreading drone weight (without battery)	40.7kg	46kg
	Max Take-off weight	70kg	95kg
	Wheelbase	2025mm	2272mm
	Expand Size	Spraying drone: 2435*2541*752mm Spreading drone: 2435*2541*774mm	Spraying drone: 2845*2718*830mm Spreading drone: 2845*2718*890mm
	Folded size	Spraying drone: 979*684*752mm Spreading drone: 979*684*774mm	Spraying drone: 1066*677*830mm Spreading drone:1066*677*890mm
	No-load hovering time	17.5min (Test by14S 30000mah)	20min (Test by18S 30000mah)
	Full load hovering time	7.5min (Test by 14S 30000mah)	7min (Test by18S 30000mah)
Working temperature	0-40°C		
Spraying system	Spaying tank	30L	50L (recommend 45L)
	Water Pump	Volt: 12-18S Power: 30W*2 Max flow: 8L/min*2	
	Nozzle	Vollt: 12-18S Power: 500W*2 Atomized particle size: 50-500µm	
	Spray width	4-8m	
Spreading system	Spreading tank	50L	70L
	Max load	30kg	50kg
	Applicable granule	0.5-6mm dry solids	
	Spread width	8-12m	
Motor system	Model	11115	11122
	Volt	14S	18S
	KV	95kv	60kv
	Maximum power	7350W	9730W
	Continuous power	2600w	3100w
	Propeller size	43inch	48inch

Flight control	Operating Voltage	12-80V	
	Working temperature	-10~60°C	
	RTK	Level±0.1m, Vertical ±0.1m	
	GPS	Level±1.5m, Vertical±0.5m	
	Wind resistance level	Sustained wind: level4, Gust: level5	
Remote control	Resolution	1080*1920	
	display screen	5.5inch	
	Working time	12h	
	Charging time	5h (20W)	
	Control distance	3km (3mHeight without shelter)	
	Weight	850g	
Recommended battery	Volt	14S	18S
	Capacity	30000mah	30000mah

Note: The weight fluctuation is ± 1 kg according to the real operation and process.

EFT has the right to update and final interpretation of this manual, and has the right to update, revise or remove the "User Manual", "Assembly Manual", software, firmware, etc. product information on all web sites without prior notice.

If you have any questions about this document, please contact our Technical Support team via email: Infor @effort-tech.com.

Video Tutorial:

For detailed tutorial videos, please follow EFT official channel

YouTube: https://youtu.be/z0x_DViC1Wg

Manufacturer :

EFT Electronic Technology Co. Ltd.

Address: Building C2, Intelligent Technology Park, 3963 Susong Road, Shushan District, Hefei , Anhui, China.

Tel: 0551-65536542

Mail: infor@effort-tech.com

Web: www.effort-tech.com